

Mecmesin

testing to perfection

Digital Force & Torque Gauges

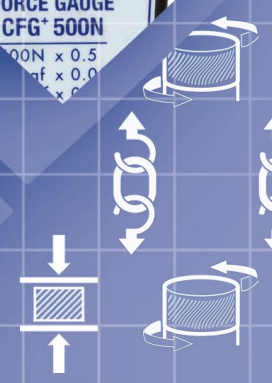

Advanced Force Gauge

Outstanding accuracy combined with extensive features

The Advanced Force Gauge (AFG) is the most versatile and fully-featured digital force gauge on the market. It can be used hand-held or fixed to a manual or motorised test stand to allow testing under controlled speed conditions. The AFG is fitted with a high-precision “internal” loadcell accurate to $\pm 0.1\%$ of full scale. For added flexibility the AFG is able to recognise data from a range of external ‘Smart’ force and torque sensors, so you can use it as a universal display for remote applications (see pages 5 to 10).

Key Features:

- Accuracy $\pm 0.1\%$ of full-scale
- 10 capacities - from 2.5 N to 2500 N
- Peak capture - Ultimate max + 1st peak
- Data output - RS232, digimatic and analogue
- Pass/Fail Alarms - audible and visual
- Overload warning with trend bar
- Wide range of grips and fixtures

RS232, Mitutoyo, Analogue data output for easy data transmission. A calibrated analogue output can be supplied as an option

 RS232 to Bluetooth adaptor (optional extra)

Recognises data from a range of external force & torque transducers see pages 5-10

View the 1st peak and ultimate peak readings
On-board memory stores up to 500 readings

Highly Accurate to $\pm 0.1\%$ full-scale

Internal loadcell stud for quick and easy change of accessories and fixtures. Loadcell stud 10-32 UNF male (5/16 UNC male for AFG 1000 N & 2500 N)

Audible & visual pass/fail alarms set a threshold for immediate alert when limits are exceeded

Measurements made in N, kN, mN, lbf, ozf, kgf and gf with a sampling rate of 5000 Hz

Reversible display - view readings even when the gauge is positioned away from you

Rugged metal housing ideal for factory or outdoor use



AFG Specification Table - Capacity & Resolution (eg 250 N x 0.05 N)

Model	Part No.	mN	N	kN	gf	kgf	ozf	lbf
AFG 2.5	850-412	2500 x 0.5	2.5 x 0.0005	-	250 x 0.05	-	9 x 0.002	0.55 x 0.0001
AFG 5	850-413	5000 x 1	5 x 0.001	-	500 x 0.1	0.5 x 0.0001	18 x 0.005	1.1 x 0.0002
AFG 10	850-414	10000 x 2	10 x 0.002	-	1000 x 0.2	1 x 0.0002	35 x 0.01	2.2 x 0.0005
AFG 25	850-415	25000 x 5	25 x 0.005	-	2500 x 0.5	2.5 x 0.0005	90 x 0.02	5.5 x 0.001
AFG 50	850-416	50000 x 10	50 x 0.01	-	5000 x 1	5 x 0.001	180 x 0.05	11 x 0.002
AFG 100	850-417	-	100 x 0.02	-	10000 x 2	10 x 0.002	350 x 0.1	22 x 0.005
AFG 250	850-418	-	250 x 0.05	-	25000 x 5	25 x 0.005	900 x 0.2	55 x 0.01
AFG 500	850-419	-	500 x 0.1	-	50000 x 10	50 x 0.01	1800 x 0.5	110 x 0.02
AFG 1000	850-420	-	1000 x 0.2	1 x 0.0002	-	100 x 0.02	3500 x 1	220 x 0.05
AFG 2500	850-421	-	2500 x 0.5	2.5 x 0.0005	-	250 x 0.05	9000 x 2	550 x 0.1

• Accuracy $\pm 0.1\%$ of full scale

• Full scale deflection of loadcell typically 0.5 mm

• Operating temperature 10°C - 35°C



AFG shown mounted to the MultiTest-dV motorised test stand

The dual level design of the keypad ensures that operation of this powerful gauge is simple, thereby making it ideal for use from production shop floor to R&D.

Housed in an ergonomically shaped, rugged aluminium case, the AFG is powered by either mains-adaptor or standard rechargeable AAA batteries.

All models carry CE marking and are supplied in a robust carrying case with standard accessories and a calibration certificate traceable to UK national standards.

See page 14 for details of accessories supplied.

versatile
rugged
accurate



Pull test on anchorage points

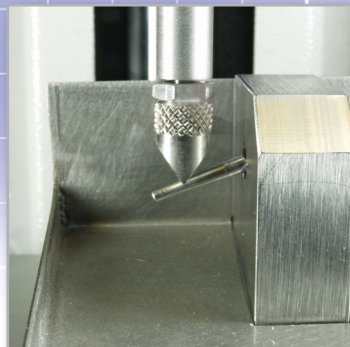

Compression test on medical device



AFG and accessories shown in carry case

Advanced Force & Torque Indicator

All the functions of the AFG but without the “internal” loadcell

The Advanced Force & Torque Indicator (AFTI) is a high-specification display unit with all the features and benefits of the AFG, for use with Mecmesin ‘Smart’ force and torque sensors. These plug one-at-a-time into the AFTI enabling it to automatically register either force or torque sensors for a variety of test applications. ‘Smart’ sensors may also be used with Mecmesin’s Advanced Force Gauge (AFG).

Force



Torque



RS232, Mitutoyo, Analogue data output for easy data transmission

Bluetooth RS232 to Bluetooth adaptor (optional extra)

Measurements made in N, lbf, kgf, kN, N.m, kgf.cm, lbf.in, gf.cm and ozf.in with a sampling rate of 5000 Hz

Overload warning with trend bar and on board memory of 500 readings

Fully interchangeable ‘Smart’ sensors - No need for additional calibration of display or sensor, just ‘Plug & Play’

Tension, compression and torque measurement with full unit conversion of displayed value

1st & ultimate peak capture



These sensors are ideal for mounting onto your own test rigs and jigs to monitor load application. They can also be used for checking calibration of your machinery to assess whether it is applying the expected load.

'Smart' Force & Torque Sensors

All sensors are fitted with 1.5 m cable length, are fully interchangeable and are supplied with Calibration Certificates traceable to UK National Standards. As standard they are delivered in cardboard transit cases.

Key Features:

- Sensors for torque, tension & compression
- Calibration Certificates traceable to UK National Standards
- Resolution - 1:5000
- Overload warning feature
- 1.5 m cable length as standard - longer cable available upon request

force & torque plug-in sensors adaptable

All dimensions quoted for the force and torque sensors are for reference only. Please contact the Mecmesin Sales Department for tolerance information if your application is dimensionally critical.

Overload protection by software warning is typically 120% of full scale for all items (without accessories), with additional mechanical overload protection being up to a minimum of 150% of full scale.

All gauges and sensors are calibrated under controlled laboratory conditions at a temperature of $20^{\circ}\text{C} \pm 2^{\circ}\text{C}$. Resolution for all sensors is typically 1:5000 - e.g. a 5000 N loadcell resolves to 1 N.

Bluetooth/USB Adaptor



- Cableless Communication
- Range in excess of 30 metres
- Easy-to-use, just 'Plug & Play'
- Maximum flexibility for data transfer
- Connects to AFG & AFTI

Tension & Compression Sensors

“Smart” Sensors for use with AFTI display or Advanced Force Gauge (AFG)

Junior S-Beam - ‘Smart’

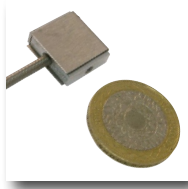

The Junior S-Beam is suitable for measuring tension and compression. Ideal for applications where available space is limited. Dedicated fixtures can be fitted via threaded holes.

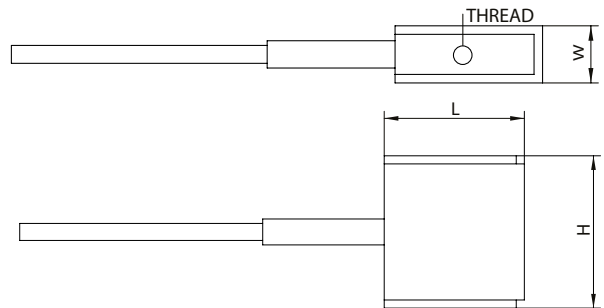

Part No.	Capacity			L (mm)	W (mm)	H (mm)	Thread
870 – 101	1 N	100 gf	3.5 ozf	17.5	7	19	M3 x 0.5
870 – 102	2.5 N	250 gf	9 ozf	17.5	7	19	M3 x 0.5
870 – 103	5 N	500 gf	18 ozf	17.5	7	19	M3 x 0.5
870 – 104	10 N	1 kgf	2.2 lbf	17.5	7	19	M3 x 0.5
870 – 105	25 N	2.5 kgf	5.5 lbf	17.5	7	19	M3 x 0.5
870 – 106	50 N	5 kgf	11 lbf	17.5	7	19	M3 x 0.5
870 – 107	100 N	10 kgf	22 lbf	17.5	7	19	M3 x 0.5
870 – 108	250 N	25 kgf	55 lbf	17.5	7	19	M3 x 0.5
870 – 109	500 N	50 kgf	110 lbf	17.5	7	19	M3 x 0.5

Accuracy $\pm 0.25\%$ of full scale



S-Beam - ‘Smart’

The S-Beam provides an economical solution to general force measurement applications where space is not restricted. Dedicated fixtures can be fitted via threaded holes.

Part No.	Capacity			L (mm)	W (mm)**	H (mm)	Thread
870 – 002	100 N	10 kgf	22 lbf	51	13	64	M6 x 1
870 – 004	200 N	20 kgf	44 lbf	51	13	64	M6 x 1
870 – 009	500 N	50 kgf	110 lbf	51	19	76	M6 x 1
870 – 001	1000 N	100 kgf	220 lbf	51	19	76	M10 x 1.5
870 – 006	2500 N	250 kgf	550 lbf	51	25	76	M12 x 1.75
870 – 008	5000 N	500 kgf	1100 lbf	51	25	76	M12 x 1.75
870 – 003	10 kN	1000 kgf	2200 lbf	51	25	76	M12 x 1.75
870 – 007	25 kN	2500 kgf	5500 lbf	76	25	108	M16 x 2

Cylindrical

Part No.	Capacity			\varnothing (mm)	H (mm)	Thread
870 - 011	*50 kN	5000 kgf	11 000 lbf	70	120	M36 x 3
870 - 010	*100 kN	10 000 kgf	22 000 lbf	70	120	M36 x 3

Accuracy $\pm 0.25\%$ of full scale * Uni-directional calibration (please specify tension or compression)

S-Beam

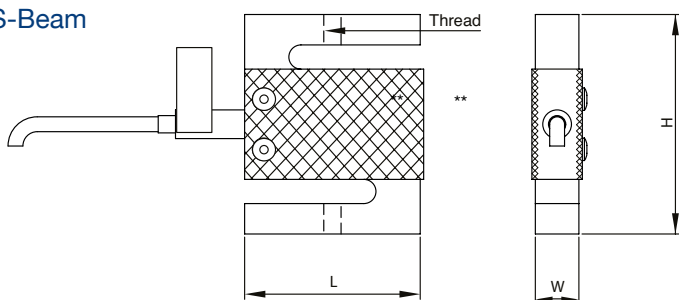

** 6mm added to the overall width of the central portion due to the protective cover

Cylindrical

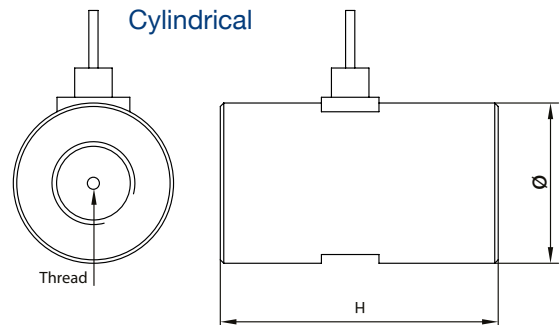

Compression Only Sensors



Load Button Cell - 'Smart'

The Load Button Cell is a miniature sensor for compression measurement only, where available space is very limited. For optimum results apply compressive load to the top of the sensor's central dome.

Miniature Series

Part No.	Capacity			ØD1 (mm)	ØD2 (mm)	ØD3 (mm)	H1 (mm)	H2 (mm)	T
878 - 008	100 N	10 kgf	22 lbf	25	5	19	8	1.3	4/40UNC
878 - 009	250 N	25 kgf	55 lbf	25	5	19	8	1.3	4/40UNC
878 - 010	500 N	50 kgf	110 lbf	31	8	25	10	1.3	6/32UNC
878 - 011	1000 N	100 kgf	220 lbf	31	8	25	10	1.3	6/32UNC
878 - 012	2500 N	250 kgf	550 lbf	31	8	25	10	1.3	6/32UNC
878 - 013	5000 N	500 kgf	1100 lbf	31	8	25	10	1.3	6/32UNC
878 - 014	10 kN	1000 kgf	2200 lbf	31	8	25	10	1.3	6/32UNC
878 - 015	20 kN	2000 kgf	5500 lbf	38	11	32	16	2	6/32UNC
878 - 016	50 kN	5000 kgf	11 000 lbf	38	11	32	16	2	6/32UNC

Accuracy ±1% of full scale

Sub-miniature Series

Part No.	Capacity			ØD1 (mm)	ØD2 (mm)	H1 (mm)	H2 (mm)
878 - 002	100 N	10 kgf	22 lbf	19	5	6.4	0.6
878 - 003	250 N	25 kgf	55 lbf	19	5	6.4	0.6
878 - 004	500 N	50 kgf	110 lbf	19	5	6.4	0.6
878 - 005	1000 N	100 kgf	220 lbf	19	5	6.4	0.6
878 - 006	5000 N	500 kgf	1100 lbf	19	5	6.4	0.6

Accuracy ±1% of full scale

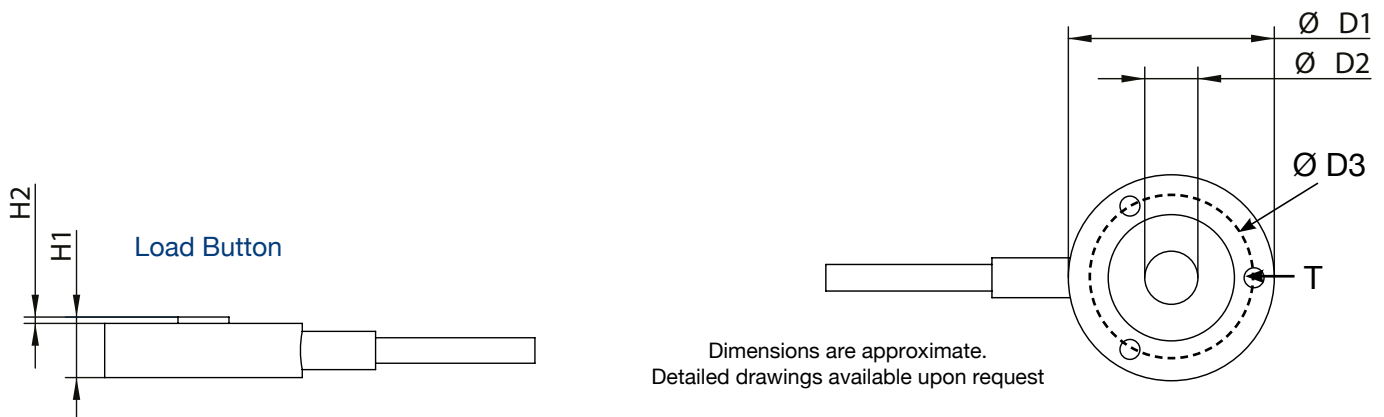

Static Torque Sensors

“Smart” Sensors for use with AFTI display or Advanced Force Gauge (AFG)



Static Torque Transducer – ‘Smart’ (low-torque)

For mounting to a bench or integrating into a complete test rig.
Equipped with ¼” HEX Socket or 3mm bore for fitting of adaptors.

Model	Part No.	Capacity				Drive		H (mm)	W (mm)	D (mm)	
TT-ST0.05	872 - 030	50	mN.m	500	gf.cm	7	ozf.in	Bore Ø3 H7	75	50	50
TT-ST0.20	872 - 032	200	mN.m	2000	gf.cm	28	ozf.in	Bore Ø3 H7	75	50	50
TT-ST0.50	872 - 033	500	mN.m	5	kgf.cm	4.5	lbf.in	¼” HEX Socket	91	50	50
TT-ST1	872 - 034	1	N.m	10	kgf.cm	9	lbf.in	¼” HEX Socket	91	50	50
TT-ST2	872 - 035	2	N.m	20	kgf.cm	18	lbf.in	¼” HEX Socket	91	50	50

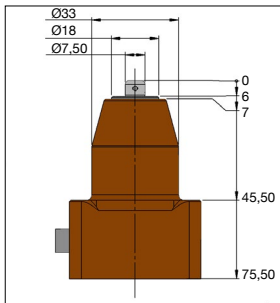

Side view of
TT-ST0.05 and TTST0.20
(Ø3 H7 bore)

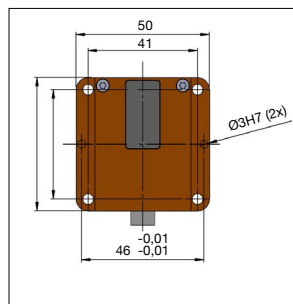

Top View of all TT models

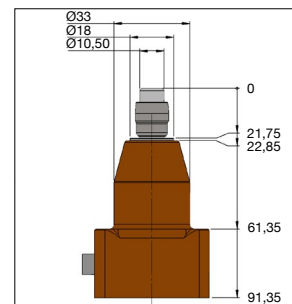

Side view of
TT-ST0.50, TT1 and TT-ST2
(¼” HEX Socket)

Accuracy ±0.5% of full scale



Static Torque Transducer - ‘Smart’ (mid & high-torque)

For mounting to a bench or integrating into a complete test rig.
Equipped with male square drive for easy fitting of adaptors.

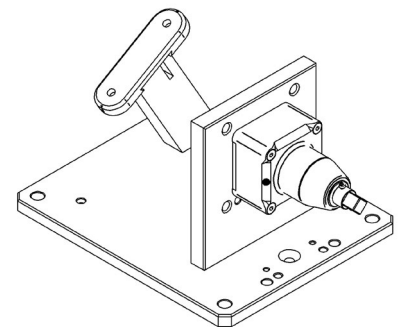
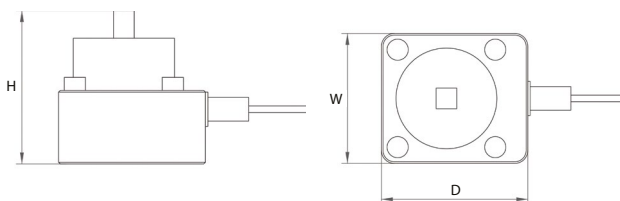

Bench Mounting Stand
Part No 432-401 suitable for ‘mid & high-torque’
ST Torque Sensors

Model	Part No.	Capacity				Sq Drive Male		H (mm)	W (mm)	D (mm)	
ST1.5	872 - 001	1.5	N.m	15	kgf.cm	13	lbf.in	3/8”	87	80	90
ST6	872 - 009	6	N.m	60	kgf.cm	53	lbf.in	3/8”	87	80	90
ST10	872 - 004	10	N.m	100	kgf.cm	90	lbf.in	3/8”	87	80	90
ST15	872 - 006	15	N.m	150	kgf.cm	133	lbf.in	3/8”	87	80	90
ST60	872 - 008	60	N.m	600	kgf.cm	530	lbf.in	3/8”	87	80	90
ST100	872 - 003	100	N.m	1000	kgf.cm	870	lbf.in	1/2”	93	80	90
ST150	872 - 005	150	N.m	1500	kgf.cm	1300	lbf.in	1/2”	93	80	90
ST600	872 - 007	600	N.m	6000	kgf.cm	5200	lbf.in	3/4”	113.5	78.7	100
ST1000	872 - 002	1000	N.m	10000	kgf.cm	8850	lbf.in	1”	124	78.7	100

Accuracy ±0.5% of full scale

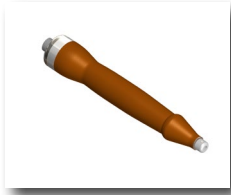

Static 'Mini' Torque Screwdriver - 'Smart' (low-torque)

For hand-held applications requiring the measurement of miniature torque below 1 N.m.

Not suitable for applications, which require multiple rotations of the sensor - use Rotary Torque Transducers (see page 9).

Model	Part No.	Capacity				Drive	L1 (mm)	Ø (mm)
TTH0.01	871 - 100	10 mN.m	100 gf.cm	1 ozf.in	Bore Ø3 H7	135	22	
TTH0.05	871 - 101	50 mN.m	500 gf.cm	7 ozf.in	Bore Ø3 H7	135	22	
TTH0.10	871 - 102	100 mN.m	1000 gf.cm	14 ozf.in	Bore Ø3 H7	135	22	
TTH0.20	871 - 105	200 mN.m	2000 gf.cm	28 ozf.in	Bore Ø3 H7	135	22	
TTH0.50	871 - 103	500 mN.m	5 kgf.cm	4.5 lbf.in	¼" HEX Socket	151	22	
TTH1	871 - 104	1 N.m	10 kgf.cm	9 lbf.in	¼" HEX Socket	151	22	

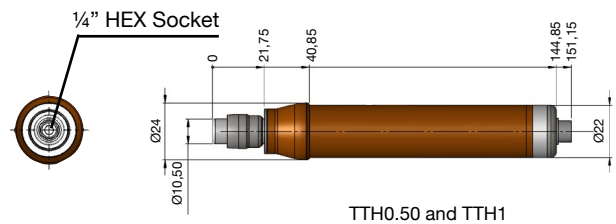
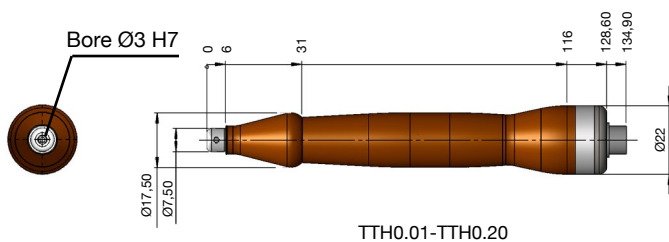

Accuracy ±0.5% of full scale



Static Torque Screwdriver - 'Smart' (mid-torque)

For mid capacity applications. Used as hand-held devices or may be mounted in a bench stand for stationary use Part No 432-402. Not suitable for applications, which require multiple rotations of the sensor - use Rotary Torque Transducers (see page 9).

Model	Part No.	Capacity				Drive	L (mm)	Ø (mm)	Weight (g)
TS0.3	871-004	0.3 N.m	3 kgf.cm	2.6 lbf.in	3/8" sq male/3 jaw chuck	143	43	660	
TS1.5	871-002	1.5 N.m	15 kgf.cm	13 lbf.in	3/8" sq male/3 jaw chuck	143	43	660	
TS3	871-003	3 N.m	30 kgf.cm	26 lbf.in	3/8" sq male/3 jaw chuck	143	43	660	
TS6	871-005	6 N.m	60 kgf.cm	53 lbf.in	3/8" sq male/3 jaw chuck	143	43	660	
TS10	871-001	10 N.m	100 kgf.cm	90 lbf.in	3/8" sq male/3 jaw chuck	143	43	660	

Supplied as standard with both 3/8" sq male drive & 3/8" opening 3 jaw chuck

Part No 432-113 1/2" opening Chuck Assembly for use with 'TS' Torque Screwdriver (optional extra)

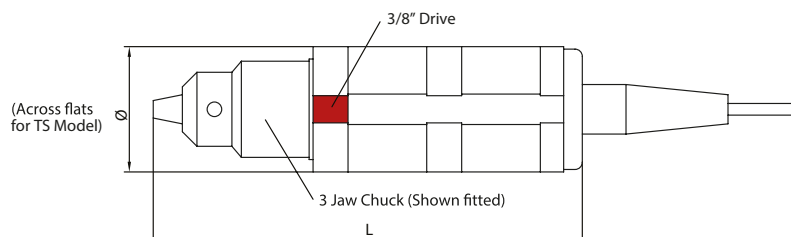

Accuracy ±0.5% of full scale

Rotary Torque Sensors

“Smart” Sensors for use with AFTI display or Advanced Force Gauge (AFG)

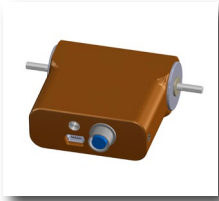

Mini Rotary Torque Transducers- ‘Smart’ (low-torque)

A complete range of mini sensors for measuring rotary torque below 1 N.m.

‘Mini’ (low-torque) TTR range

Model	Part No.	Capacity				A Shaft Length (mm)		B Shaft Ø (mm)	
TTR0.05	877 - 030	50	mN.m	500	gf.cm	7	ozf.in	11.2	Ø 3h8
TTR0.10	877 - 031	100	mN.m	1000	gf.cm	14	ozf.in	10.4	Ø 5h8
TTR0.20	877 - 032	200	mN.m	2000	gf.cm	28	ozf.in	10.4	Ø 5h8
TTR0.50	877 - 033	500	mN.m	5	kgf.cm	4.5	lbf.in	17.75	Ø 8h8
TTR1	877 - 034	1	N.m	10	kgf.cm	9	lbf.in	17.75	Ø 8h8

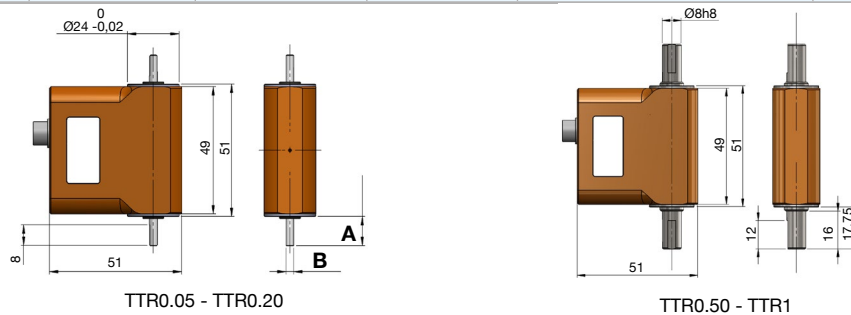

Accuracy ±0.5% of full scale

TTR0.05 - TTR0.20

TTR0.50 - TTR1



Rotary Torque Transducers - ‘Smart’ (mid & high-torque)

A complete range of sensors for measuring rotary torque. Suitable for dynamic torque applications with multiple revolutions (e.g. window-winder mechanism).

‘FAST’ (mid and high torque) range

Model	Part No.	Capacity			Drive	L1 (mm)	L2 (mm)	L3 (mm)	Ø (mm)	Max rpm			
FAST 2 N.m sq	877 - 020	2	N.m	20	kgf.cm	18	lbf.in	1/4" square	70	16	10	40	1000
FAST 2 N.m rd	877 - 021	2	N.m	20	kgf.cm	18	lbf.in	Ø 9mm round*	70	28	28	40	5000
FAST 6 N.m sq	877 - 022	6	N.m	60	kgf.cm	53	lbf.in	1/4" square	70	16	10	40	1000
FAST 6 N.m rd	877 - 023	6	N.m	60	kgf.cm	53	lbf.in	Ø 9mm round*	70	28	28	40	5000
FAST 15 N.m sq	877 - 024	15	N.m	150	kgf.cm	133	lbf.in	1/4" square	70	16	10	40	1000
FAST 15 N.m rd	877 - 025	15	N.m	150	kgf.cm	133	lbf.in	Ø 9mm round*	70	28	28	40	5000
FAST 60 N.m sq	877 - 026	60	N.m	600	kgf.cm	530	lbf.in	3/8" square*	70	24	13	50	1000
FAST 60 N.m rd	877 - 027	60	N.m	600	kgf.cm	530	lbf.in	Ø 14mm round*	70	28	28	50	5000
FAST 150 N.m sq	877 - 028	150	N.m	15.3	kgf.m	111	lbf.ft	1/2" square	70	35	19	50	1000
FAST 150 N.m rd	877 - 029	150	N.m	15.3	kgf.m	111	lbf.ft	Ø 19mm round*	70	55	55	50	5000

• Maximum axial force is 40 N • Maximum lateral radial force is 50 N

• Accuracy ±1% of full scale

* fitted with keyway

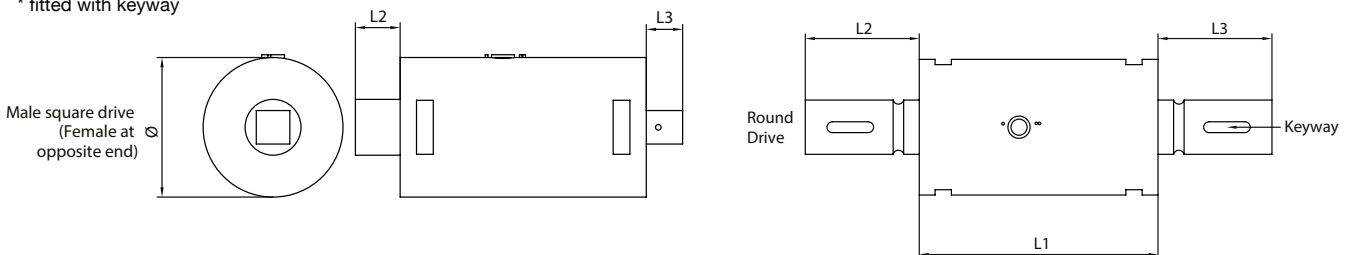

Specialised Loadcells

Specialised Loadcells - 'Smart'

In addition to the standard range of sensors, Mecmesin also offers specialised loadcells dedicated to specific applications. A few examples are shown below. Contact our sales department for further details.

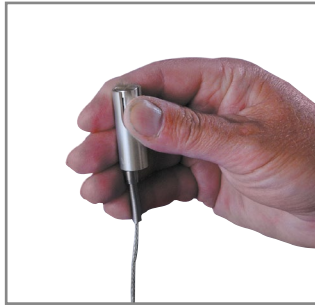

Pinch Sensor



Donut Loadcell

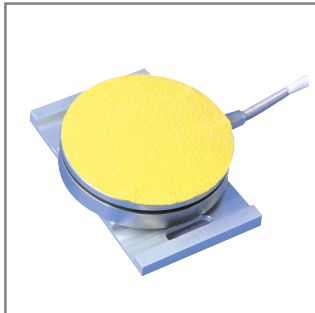

Pedal Force Accelerator

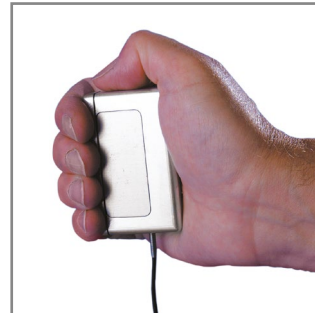

Hand Gripper



Pedal Force Accelerator in action

Basic Force Gauge

“Live” and “Peak Hold” display with data-output in metal housing

The Basic Force Gauge (BFG) is designed for easy operation and provides outstanding tension and compression measurement performance and reliability at an affordable price.

Supplied as standard with calibration certificate traceable to national standards.

Constructed in a rigid yet lightweight aluminium housing, with its ergonomically attractive shape, the BFG can be used as a hand-held instrument, or alternatively it can be mounted to manual or motorised test stands to allow testing under more controlled conditions.



BFG Specification Table - Capacity & Resolution (e.g. 200 N x 0.05 N)

Model	Part No.	mN	N	kN	gf	kgf	ozf	lbf
BFG 10	853-410	10000 x 2	10 x 0.002	-	1000 x 0.2	1 x 0.0002	35 x 0.01	2.2 x 0.0005
BFG 50	853-411	50000 x 10	50 x 0.01	-	5000 x 1	5 x 0.001	180 x 0.05	11 x 0.002
BFG 200	853-412	-	200 x 0.05	-	20000 x 5	20 x 0.005	720 x 0.2	44 x 0.01
BFG 500	853-413	-	500 x 0.1	-	50000 x 10	50 x 0.01	1800 x 0.5	110 x 0.02
BFG 1000	853-414	-	1000 x 0.2	1 x 0.0002	-	100 x 0.02	3500 x 1	220 x 0.05
BFG 2500	853-417	-	2500 x 0.5	2.5 x 0.0005	-	250 x 0.05	9000 x 2	550 x 0.1

- Accuracy $\pm 0.25\%$ of full scale
- Full scale deflection of loadcell typically 0.5 mm
- Operating temperature 10°C - 35°C

Key Features

- Accuracy $\pm 0.25\%$ of full range
- 6 capacities - from 10 N up to 2500 N
- Peak capture - in tension and compression
- Wide range of grips and fixtures

easy-to-use
ergonomic
robust



BFG shown mounted to the MDD manual test stand

All models carry CE marking and are supplied in a robust carrying case with standard accessories and a calibration certificate traceable to UK national standards.

See page 14 for details of accessories supplied.



BFG with accessories shown in carry case

Compact Force Gauge⁺

“Peak Hold” display in ABS plastic housing

The Compact Force Gauge⁺ (CFG⁺) is a pocket-sized, lightweight force gauge designed for elementary tension and compression measurement. Powered by disposable AA batteries, the CFG⁺ is delivered with a Declaration of Conformity as standard. A Calibration Certificate can be ordered separately.

Peak readings captured at 500 Hz with an accuracy of $\pm 0.5\%$ of full scale

low cost
peak hold
portable

Measurements made in N, lbf, ozf, kgf and gf with a resolution of 1:1000

Housed in a lightweight plastic case

Loadcell stud 10-32 UNF male

RS232 output for easy data transmission

The CFG⁺ provides a simple digital alternative to traditional analogue spring balances. It is ideal for users with a limited budget, who only measure on an occasional basis for non-critical applications.

CFG⁺ Specification Table

Model	Part No.	N	kgf	lbf
CFG ⁺ 50	860-021	50 x 0.05	5 x 0.005	11 x 0.01
CFG ⁺ 200	860-022	200 x 0.2	20 x 0.02	44 x 0.05
CFG ⁺ 500	860-023	500 x 0.5	50 x 0.05	110 x 0.1

• Accuracy $\pm 0.5\%$ of full scale

Note: The following units are available on the majority of CFG⁺ models.

Those that differ are marked by an asterisk with details given below:

kN*, N, mN, kgf, gf**, lbf, ozf

* Not available on the CFG⁺ 50 N

** Not available on the CFG⁺ 200 N or 500 N



Hand-held drawer testing

Accessories

Each Mecmesin gauge comes with a set of standard accessories to help perform basic tension or compression tests.

A wide selection of accessories exclusive to Mecmesin are available. See our Accessory Catalogue for an extensive range of grips and fixtures, to enable you to complete thousands of different tests. Alternatively make use of our experienced team of engineers to provide a customised grip to solve your particular problem.

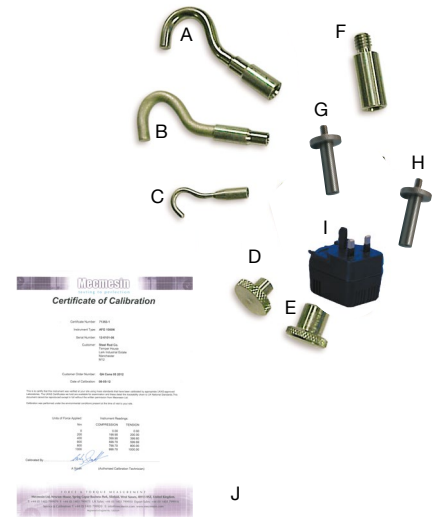

- A** 6 mm Ø - 5/16 UNC thread (432-122)
- B** 6 mm Ø - 10-32 UNF (F) (432-120)
- C** 3.2 mm Ø - 10-32 UNF (F) (432-118)
- D** 19 mm Ø - 10-32 UNF (F) (432-121)
- E** 19 mm Ø - 5/16 UNC (F) (432-125)

- F** 30 mm long - 5/16 UNC (F-M) (432-008)
- G** 30 mm - 10-32 UNF (F) to 10-32 UNF (M) (432-006)
- H** 30 mm - 10-32 UNF (F) to M6 (M) (432-007)
- I** Mains adaptor/charger (304-004) - 220V 2-pin round (304-005) - 220V 3-pin square (304-006) - 110V 2-pin flat
- J** Calibration certificate traceable to national standards

* Part numbers shown in brackets

Table of standard accessories delivered with each gauge:

Model	Capacity	A	B	C	D	E	F	G	H	I	J
AFG	2.5, 5, 10, 25, 50 N			•	•			•	•	•	•
AFG	100, 250, 500 N		•		•			•	•	•	•
AFG	1000, 2500 N	•				•	•			•	•
BFG	10, 50 N			•	•			•	•	•	•
BFG	200, 500 N		•		•			•	•	•	•
BFG	1000, 2500 N	•				•	•			•	•
CFG+	50 N			•	•			•	•		
CFG+	200 N		•		•			•	•		
CFG+	500 N		•		•			•	•		

Service & Calibration

Mecmesin ensures all customers receive a high level of on-going service and support. This includes offering a prompt and cost-effective calibration service. Though calibrations can be completed in our comprehensive in-house facility, customers also have the option of our on-site calibration service.



Mecmesin

testing to perfection

Mecmesin - a world leader in affordable force and torque testing solutions

Since 1977, Mecmesin has assisted thousands of companies achieve enhanced quality control in design and production. The Mecmesin brand represents excellence in accuracy, build, service, and value. In production centres and research labs worldwide, designers, engineers, operators, and quality managers endorse Mecmesin force and torque testing systems for their high performance across countless applications.

www.mecmesin.com



Algeria	Hungary	Philippines
Argentina	India	Poland
Australia	Indonesia	Portugal
Austria	Iran	Romania
Bangladesh	Ireland	Russia
Belgium	Israel	Saudi Arabia
Brazil	Italy	Serbia
Bulgaria	Japan	Singapore
Cambodia	Korea	Slovakia
Canada	Kosovo	Slovenia
Chile	Laos	South Africa
China	Latvia	Spain
Colombia	Lebanon	Sri Lanka
Costa Rica	Lithuania	Sweden
Croatia	Macedonia	Switzerland
Czech Republic	Malaysia	Syria
Denmark	Mexico	Taiwan
Ecuador	Morocco	Thailand
Egypt	Myanmar	Tunisia
Estonia	Netherlands	Turkey
Finland	New Zealand	UK
France	Norway	Uruguay
Germany	Paraguay	USA
Greece	Peru	Vietnam

The Mecmesin global distribution network guarantees your testing solution is rapidly delivered and efficiently serviced, wherever you are



FS 58553

Mecmesin reserves the right to alter equipment specifications without prior notice. E&OE

DISTRIBUTOR STAMP

Head Office Mecmesin Limited

w: www.mecmesin.com
e: sales@mecmesin.com

North America Mecmesin Corporation

w: www.mecmesincorp.com
e: info@mecmesincorp.com

France Mecmesin France

w: www.mecmesin.fr
e: contact@mecmesin.fr

Asia Mecmesin Asia Co. Ltd

w: www.mecmesinasia.com
e: sales@mecmesinasia.com

Germany Mecmesin GmbH

w: www.mecmesin.de
e: info@mecmesin.de

China Mecmesin (Shanghai) Pte Ltd

w: www.mecmesin.cn
e: sales@mecmesin.cn