

Mecmesin

testing to perfection

OmniTest™

Universal Testing Machine

featuring VectorPro™ MT materials testing software



Tensile strength



Compression



Flexure / Bend



Stress



Strain



Force control

OmniTest™

Universal Testing Machine for product & materials testing

Building on over 40 years experience in force measurement for product testing, Mecmesin has developed the OmniTest Universal Testing Machine (UTM) with VectorPro MT software to perform a range of product and materials testing procedures. A range of rigid test frames enables the properties of metals, plastics, polymers, alloys, composites, wood, fabrics, glass, laminates and ceramics to be accurately characterised in tension and compression up to 50 kN.



Testing in accordance with international standards is a key part of determining materials characteristics whether it be for incoming Quality Assurance, R&D or production Quality Control purposes. With this in mind the OmniTest with VectorPro MT software has been designed to meet the challenge of being powerful, versatile yet easy-to-use with minimal operator training.

4 simple steps are all it takes to configure to your exact requirements:

1. Choose your OmniTest bench-top frame to apply loads - from 5 kN to 50 kN capacity
2. Select from the ELS range of precision, interchangeable load sensors to record applied loads
3. To hold your specimen add suitable grips and fixtures from our wide collection
4. Easily configure VectorPro MT software to meet your own specific test methods



The OmniTest™ Range – up to 50 kN

The OmniTest range comprises four bench-mounted, static-load testing machines allowing tensile and compressive forces to be applied to a wide variety of material properties, specimen configurations and test types.

All frames feature excellent rigidity with minimal deflection, upper & lower safety limit switches and have ample space to accommodate most sizes of test specimen.

Choose the frame load rating and test space suited to your specimen's expected size and stress-strain characteristics.



◀ **Single column**
OmniTest 5: for loads up to 5 kN



Twin column ▲
OmniTest 10: for loads up to 10 kN
OmniTest 25: for loads up to 25 kN
OmniTest 50: for loads up to 50 kN

OmniTest™ Key Features

4 models

- Test materials with a wide range of strength and elongation properties.
- Load capacity (crosshead travel)
 - 5 kN (650 mm)
 - 10 kN (950 mm)
 - 25 kN (950 mm)
 - 50 kN (1100 mm)

Convenient workspace aids

- Accessible upper and lower safety limit switches
- T-slot for PC tablet mounting, or other accessories (e.g. camera or barcode reader)

VectorPro MT software

- Extensive suite of calculations for materials testing
- Database architecture and strict operator permissions ideal for use in FDA 21 CFR Part 11 compliant environments



Control panel and display

- Just four multifunction buttons for settings and operation
- Clear indication of load, displacement, speed and system status

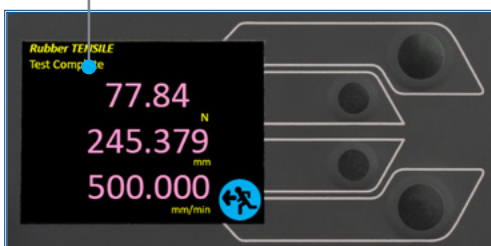

Accurate and versatile loading

- Enhanced Load Sensors (ELS) with excellent accuracy of +/- 0.5% of reading down to 5% of range
- Active load holding and rate control (load ramping)

Modern design architecture

- Rigid frame with minimal deflection
- Robust lightweight construction
- Integrated cable management

Versatile and precise

- Outstanding speed range
- Precise positional resolution

Extensometer ready

- In-built connectivity
- Software for materials analysis
- Strain measurement and control
- Active strain control

Grips and fixtures

- A wide range of grips and fixtures available to hold test specimens



Multifunction wheel

- Fine control allows precise setting of speed and position.
- Coloured LEDs clearly indicate machine status during testing.
- Precision jog mode to finely position the crosshead for fitting of specimens into grips

(Model shown: single column OmniTest™ 5, features may vary for other models)

OmniTest™ Controls

The OmniTest has a convenient, simple-to-use front panel for selection of display parameters and precise jog-control for rapid crosshead positioning.

Sophisticated internal electronics communicate seamlessly with VectorPro MT software to efficiently perform the test procedure.



	<p>▲ Green light Pulsating: Ready to start test Rotating: Scrolling through a menu</p>	<p>▲ Amber light Static: Test completed Rotating: Crosshead moving</p>	<p>▲ Red light Static: Test stopped/limit triggered</p>

Enhanced Load Sensors

A comprehensive range of new Enhanced Load Sensors (ELS) has been designed to communicate with the OmniTest, delivering superior performance to meet the specific requirements of materials testing—even for brittle specimens. Improved accuracy of $\pm 0.5\%$ of reading allows more tests to be performed without changing the load sensor. However, in situations where multiple load ranges are required, the ELS sensors are fully interchangeable in a few seconds with automatic recognition of calibration details by VectorPro MT software when connected.

Machine control

The ELS integration with the OmniTest and VectorPro MT enables active force control to simulate real-world scenarios.

- Active load holding to apply and maintain a constant stress or load even on very stiff test specimens
- Active load rate control (stress rate control) or load-ramping (N/sec)
- Active strain control, independent of the crosshead displacement, to avoid pre-stressing the specimen

An internal sampling rate of 20 kHz is standard with data transfer via USB at a maximum of 1000 Hz to prevent noise and spikes being erroneously presented.



OmniTest™ accessories

Grips and Fixtures

To complete your UTM system Mecmesin offers an extensive array of accessories approved for use with OmniTest. Secure, distortion-free gripping which does not damage the specimen, introduce localised stresses, or restrict its deformation is fundamental in obtaining repeatable and valid test results.



Selection of grips ideal for materials testing

The top-quality range of standard compressive and tensile fixtures includes application-specific options such as jaw size and surface finish to comply with the specifications of international standards. If custom grips are required our in-house application engineers can design and manufacture these to suit your needs.

OmniTest is a universal testing machine and can also perform other tensile and compression tests on product specimens, when fitted with the appropriate accessories.



Axial Extensometers

OmniTest has a direct input connection for an extensometer, to correctly measure the true elongation of the gauge length region of the specimen, enabling VectorPro MT to accurately calculate the strain for elastic, ductile and brittle materials.

Mecmesin offers a choice of digital contacting extensometry recommended for use with OmniTest.



Specifications

OmniTest		5	10	25	50
Rated capacities	kN	5	10	25	50
	kgf	500	1000	2500	5000
	lbf	1100	2200	5500	11000
Number of ballscrews		1	2	2	2
Data-acquisition rate		500 Hz			
Internal sampling rate (load)		20 kHz			
Displacement***					
Crosshead travel*		650 mm (25.6")	950 mm (37.4")	950 mm (37.4")	1100 mm (43.3")
Resolution		1 μ m			
Accuracy		$\pm 0.1\%$ of indicated position or ± 10 microns, whichever is greatest			
Speed					
Speed range	mm/min	0.05 to 1200			
	in/min	0.002 to 47.2			
Speed resolution		0.001 mm/min (0.00004 in/min)	0.001 mm/min (0.00004 in/min)	0.001 mm/min (0.00004 in/min)	0.001 mm/min (0.00004 in/min)
Accuracy		$\pm 0.1\%$ or ± 20 microns/min of indicated speed (at steady state) whichever is greatest			
Dimensions					
Distance between columns		–	400 mm (15.7")	400 mm (15.7")	420 mm (16.5")
Throat depth**		100 mm (3.9")	–	–	–
Height		1089 mm (42.9")	1500 mm (59.1")	1500 mm (59.1")	1931 mm (76")
Width		330 mm (13.0")	826 mm (32.5")	826 mm (32.5")	864 mm (34")
Depth		570 mm (22.4")	542 mm (21.3")	542 mm (21.3")	572 mm (22.5")
Vertical daylight*		700 mm (27.6")	1180 mm (46.5")	1140 mm (44.9")	1330 mm (52.4")
Weight		70 kg (155 lbs)	140 kg (309 lbs)	140 kg (309 lbs)	285 kg (628 lbs)
Electrical supply					
Voltage		230V AC 50 Hz or 110V AC 60 Hz			
Maximum power requirements		150 watts	400 watts	450 watts	450 watts
Enhanced Load Sensors (ELS)					
Accuracy		$\pm 0.5\%$ of reading down to 5% of range. Class 0.5, according to the requirements of ISO 7500-1			
Resolution		$>1:25000$ filtered from 24 bit			
Environment specification					
Operating temperature		10°C to 40°C			
Operating relative humidity		30% - 80% (non-condensing)			

* Measured without fixtures ** Measured on centreline of load sensor *** Correction for system compliance is available

Software and communications	
Connectivity	USB port, extensometer input, 3 x low voltage additional sensor inputs with future expansion capability
PC requirements (recommended)	Intel Core i5 processor, 8 GB RAM, one USB 2.0 or 3.0 port, SSD hard drive with 10 GB free space, screen resolution 1920x1080 full HD
PC requirements (minimum)	Intel/AMD dual core processor with 2 GHz or faster clock speed, 4 GB RAM, one USB 2.0 or 3.0 port, hard drive with 10 GB free space, screen resolution 1080x720
Operating system (OS)	Compatible OS: Windows 7 or Windows 10 (32 or 64 bit) Recommended OS: Windows 10 Pro 64 bit
Data output	You can export as PDF, XLSX, CSV, TXT, Email and image files

Dimensions

OmniTest 5 kN

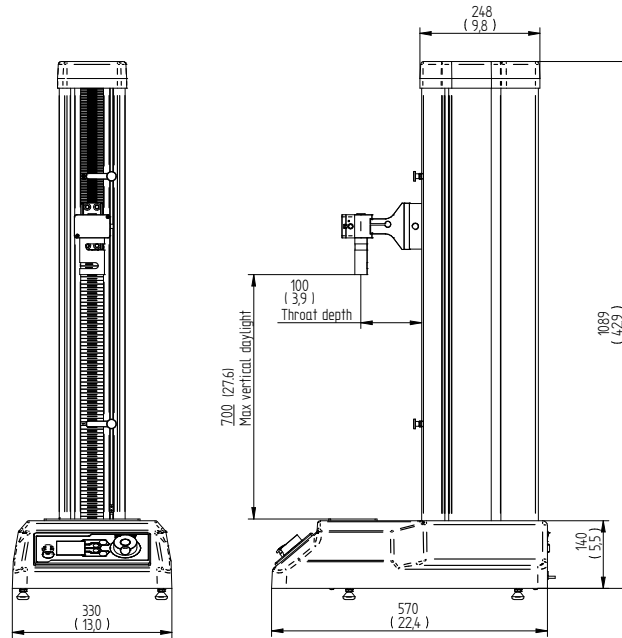

OmniTest 10 kN, 25 kN

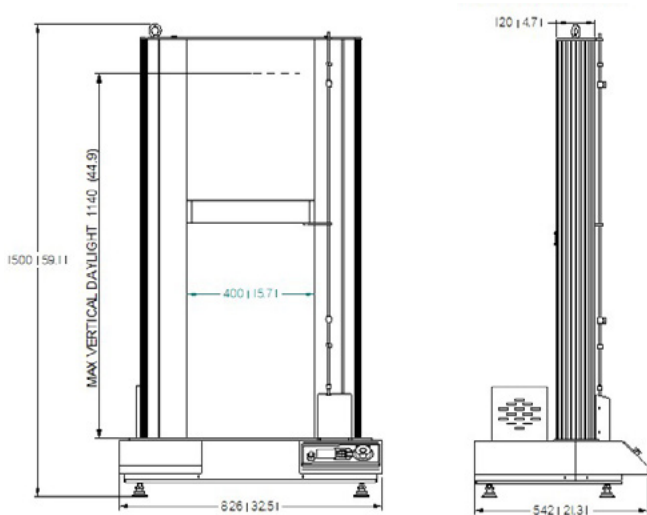

OmniTest 50 kN

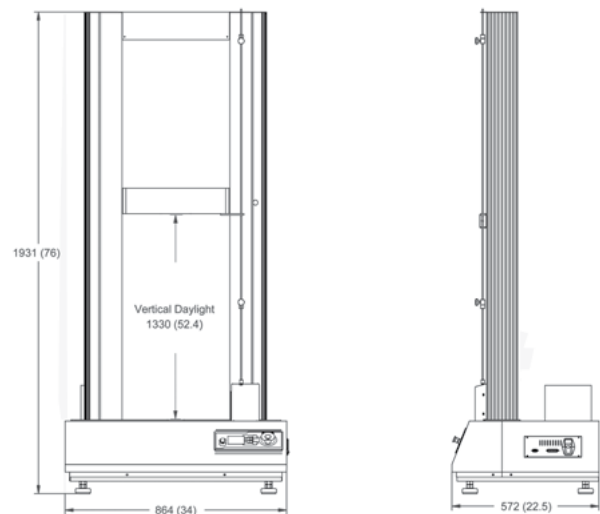

All measurements are in millimetres and (inches)

VectorPro™ MT

Product and materials testing software



VectorPro MT software has been designed to work with the OmniTest range of bench-top frames to efficiently perform both product & materials testing procedures. Its clear icon-driven user-interface ensures it is completely intuitive to use with the minimum of training. Together with in-built

stress-strain calculations and powerful reporting tools, it is the ideal choice for quality assurance checks at the production line and in the QC lab or, for more in-depth analysis of material properties, in the R&D laboratory.

For medical & pharmaceutical clients the database architecture provides audit trail and e-signature functionality to help facilitate compliance to FDA 21 CFR Part 11.



VectorPro™ MT summary of key features

Simplicity

- Simple, workflow-focussed design featuring an intuitive drag-and-drop Graphical User Interface
- Personalised user-accounts with simplified workspaces for quick access to all tests and commonly-used favourites
- 'Prompt for Value' feature requires a compulsory user-input before performing the test to ensure no essential information is missed
- Icon-driven approach to enhance clarity for users
- Instant pass/fail indication according to your specification criteria
- Touch screen enabled

Control

- Universal tensile and compression testing capability for general product tests
- Stress-Strain machine control and data analysis: test in both tensile and compressive directions by running to target load, position, stress, strain and break
- Permissions-based log-on with password protection to control who can create or run tests, view results, and produce reports
- System Deflection Compensation (known also as 'Correction for Machine Compliance') ensures the most accurate deformation and strain readings when an extensometer cannot be used. This is achieved by compensating for the intrinsic movement of the frame and loadcell during the test leaving only the deformation of the specimen



Versatility

- Ability to change graph axes between stress, strain, load, displacement, time to better understand the test data
- Customisable results table and PDF reporting tool—present the data the way that you and your customer wish to see it
- Export data to Excel or in a format suitable for SPC software packages—easily networkable for remote access by supervisors and managers
- Language customisation—use the same software across your company's world-wide locations. Full support and back-up from Mecmesin's international distributors is assured

Building test procedures

VectorPro MT features a drag and drop methodology to apply all the operations needed to create a test program, apply common stress-strain calculations and build reports. Using icon-driven prompts create even the most elaborate test routines in moments and refine them as you go.

The interface guides the user to build test sequences and select standard specimen types and operations based on the type of test being conducted.

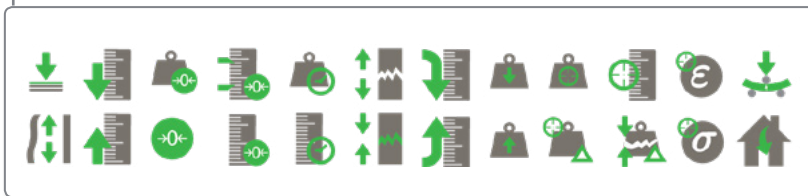
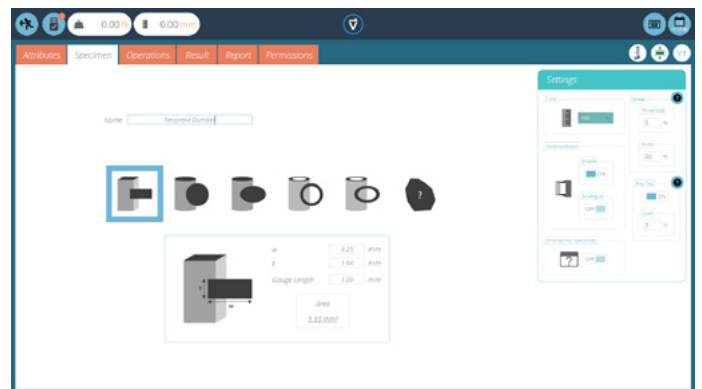
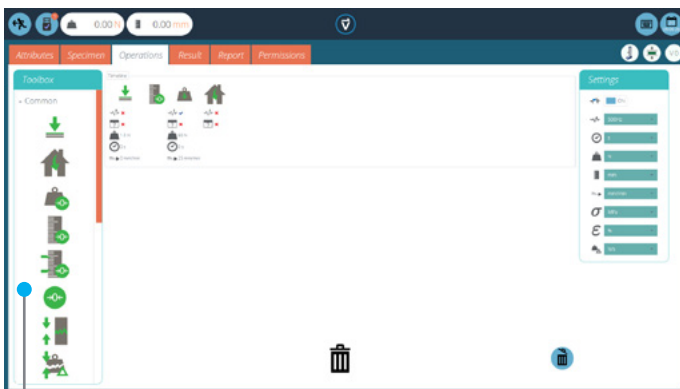
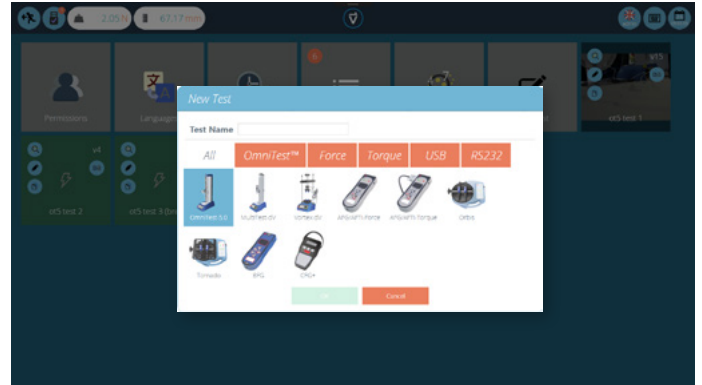

◀ Drag pre-test, in-test, and post-test operations onto the procedure timeline

Apply materials testing calculations and validation criteria

In addition to all traditional product testing calculations (peak load, average load, load at displacement etc.), VectorPro MT includes a comprehensive range of stress-strain domain calculations, available to be included in the results analysis of the test routine. Pass/fail parameters can be easily added for each calculation and clearly displayed to operators.

Included calculations:

- Elastic Modulus (Young's Modulus)
- 0.2% Offset Yield
- Yield (steel and plastic)
- Ultimate tensile strength (UTS)
- Stress and Strain at Break
- Flexural modulus 3 & 4 point

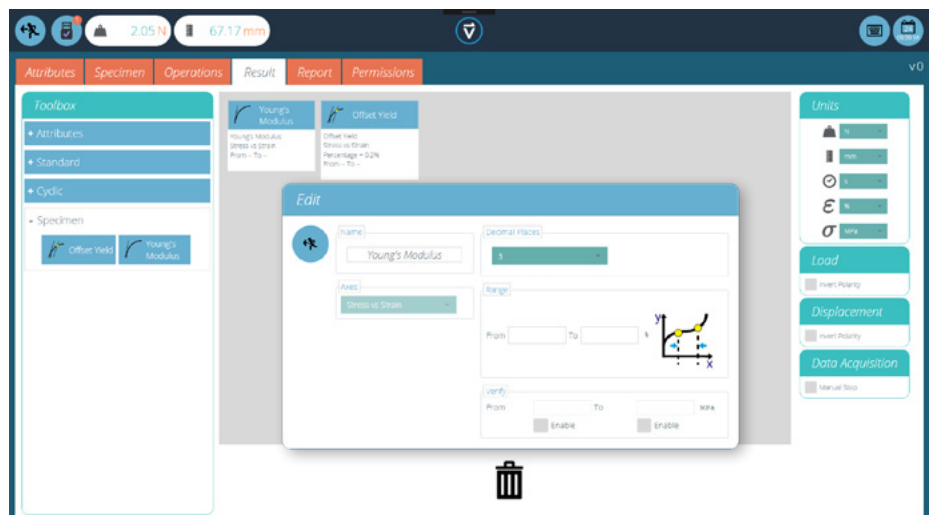

Real time plotting of test data

- View tests as they run, with instant calculation of pass/fail results
- Get in close to analyse your specimen data— switch axes, zoom in, pan across, view the value of individual data points
- Offset specimen traces on the graph for greater clarity and comparison
- All plots and results are stored automatically for later review at any time
- Switch axes to display graphs in the most relevant view for the data and test type

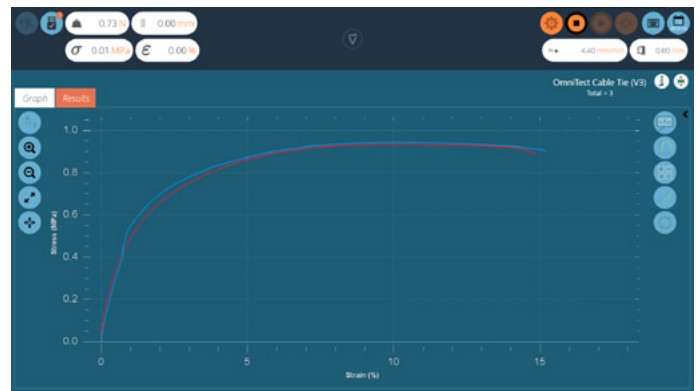
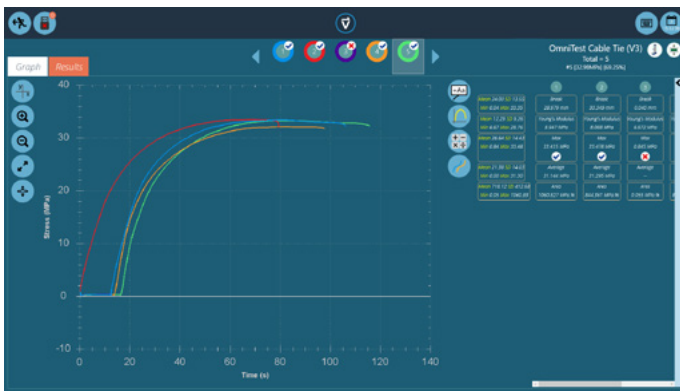

Results handling and report generation

- Complete flexibility to compare the plots of all tested specimens or simply select out the specimens you wish to compare
- Add spot calculations not included in the original test profile view temporarily
- Select out the specimens you want to compare, and adjust calculation parameters temporarily or to save
- Link to the network so managers and operators alike can review test results remotely at their convenience
- Export raw data or test results to Excel files
- Automatically email a table of results at end of test
- Compare the plots of tested specimens across different test methods
- Create a test report including company logos, test results, graphs and notes, then print or save as PDF

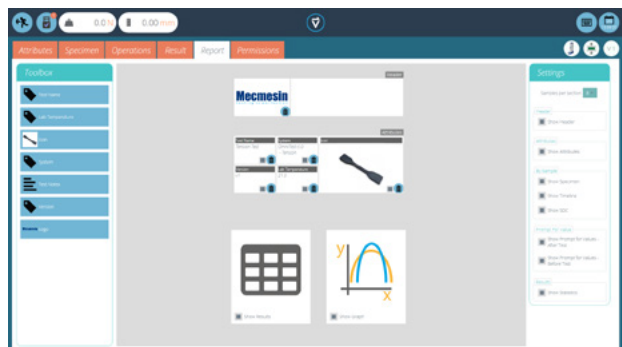
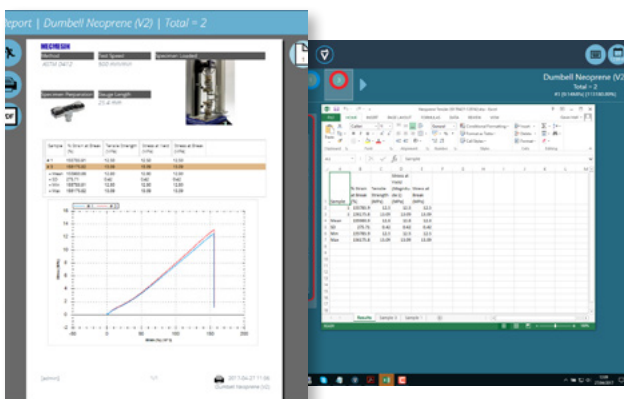
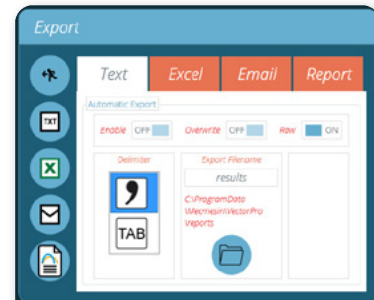

Designed for FDA 21 CFR Part 11 Environments

VectorPro MT is designed to help facilitate meeting FDA 21 CFR Part 11 requirements, incorporating the following features:

- Time stamped Event Log entries:
 - Operator ID
 - Description of action
 - Supervisor comment
- Supervisor authorisation
- Only viewable by the administrator
- Print option



Events

Event Log

admin
admin
admin
admin
admin
admin
admin
admin
admin

Event Log
Select Test
Select Test
Login
Test Results
Test Results
Report Designer
Report Designer
Application

Open
Close
Open
Execute
Delete
Delete
Delete
New
Close

None
None
None
None
Test Result
Test Result
Report Item Header
Report Item Header
None

Σ= 10

02/03/2018 11:31:50
Cancel

Calibration

ELS load cells will be adjusted and calibrated using our proprietary internal methods and issued with certificates conforming to the requirements of ISO/IEC 17025. UKAS accredited calibrations are available on request. Calibrations are carried out using masses and reference sensors traceable to International standards. The design accuracy for ELS load cells is $\pm 0.5\%$ of reading from 5% to 100% of load cell range.



Mecmesin - a world leader in affordable force and torque testing solutions

Since 1977, Mecmesin has assisted thousands of companies achieve enhanced quality control in design and production. The Mecmesin brand represents excellence in accuracy, build, service, and value. In production centres and research labs worldwide, designers, engineers, operators, and quality managers endorse Mecmesin force and torque testing systems for their high performance across countless applications.

www.mecmesin.com



- | | | |
|----------------|-------------|--------------|
| Algeria | India | Poland |
| Argentina | Indonesia | Portugal |
| Australia | Iran | Romania |
| Austria | Ireland | Russia |
| Bangladesh | Israel | Saudi Arabia |
| Belgium | Italy | Serbia |
| Brazil | Japan | Singapore |
| Bulgaria | Korea | Slovakia |
| Cambodia | Kosovo | Slovenia |
| Canada | Kuwait | South Africa |
| Chile | Laos | Spain |
| China | Latvia | Sri Lanka |
| Colombia | Lebanon | Sweden |
| Costa Rica | Lithuania | Switzerland |
| Croatia | Macedonia | Syria |
| Czech Republic | Malaysia | Taiwan |
| Denmark | Mexico | Thailand |
| Ecuador | Morocco | Tunisia |
| Egypt | Myanmar | Turkey |
| Estonia | Netherlands | UAE |
| Finland | New Zealand | UK |
| France | Norway | Uruguay |
| Germany | Paraguay | USA |
| Greece | Peru | Vietnam |
| Hungary | Philippines | |

The Mecmesin global distribution network guarantees your testing solution is rapidly delivered and efficiently serviced, wherever you are.



FS 58553

Mecmesin reserves the right to alter equipment specifications without prior notice. E&OE

DISTRIBUTOR STAMP

Head Office - UK Mecmesin Limited

w: www.mecmesin.com
e: sales@mecmesin.com

North America Mecmesin Corporation

w: www.mecmesincorp.com
e: info@mecmesincorp.com

France Mecmesin France

w: www.mecmesin.fr
e: contact@mecmesin.fr

Asia Mecmesin Asia Co., Ltd

w: www.mecmesinasia.com
e: sales@mecmesinasia.com

Germany Mecmesin GmbH

w: www.mecmesin.de
e: info@mecmesin.de

China Mecmesin (Shanghai) Pte Ltd

w: www.mecmesin.cn
e: sales@mecmesin.cn